

IMT-USB-M2-50200-A85 50MP Auto Focus USB 2.0 Camera Module

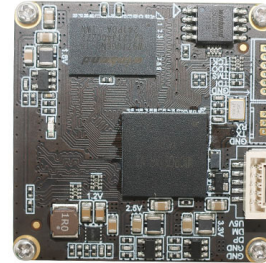

Front View



Back View

IMT-USB-M2-50200-A85 is a 50MP Auto Focus USB camera module based on 1/1.56" image sensor. This AF camera enables PDAF and CDAF, supporting the optional digital zoom. It delivers 8192 x 6144 resolution at 1.00um pixels with 4K high quality images and 3D noise reduction function. The ultra small size lens enables captures wide view angle. This camera module is ideal solution for video conferencing, live broadcast, industrial equipment, media equipment, smart home, robotics, self-service equipment, advertising machines, all-in-one machines, display stands, computer cameras.

Key Features

- 50 Megapixels 8192 x 6144 array at 5 FPS
- High speed USB 2.0 Plug and Play
- MJPEG output format
- Low power consumption
- Compact size 38x38 mm
- UVC compliant to Windows, Linux, OS with UVC UAC driver
- USB OTG (On-The-Go) Support

IMT-USB-M2-50200-A85 50MP Auto Focus USB 2.0 Camera Module

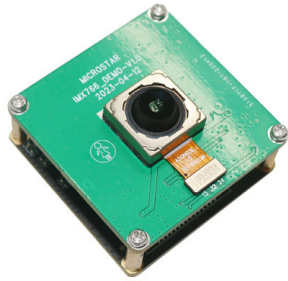

Top View

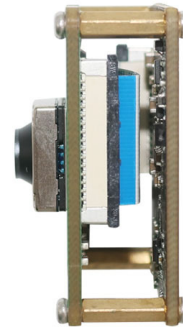

Side View



Bottom View



USB Cable



IMT-USB-M2-50200-A85 50MP Auto Focus USB 2.0 Camera Module

Camera Module No.	IMT-USB-M2-50200-A85
Image Sensor	50MP 4K
Sensor Type	1/1.56"
Pixel Size	1.00 um x 1.00 um
Resolution	8192 x 6144 @ 5 FPS
Digital Zoom	Supported
F. NO.	1.80
View Angle	85.5°(DFOV)
Lens Dimensions	13.50 x 13.50 mm
Module Type	Auto Focus PDAF CDAF
Interface	USB 2.0
Output Format	MJPG
Auto Control	Saturation, Contrast, Acutance White Balance, Exposure
Audio (Optional)	Digital Microphone, Single, Dual Channel
Input Voltage	DC 5V
Working Current	Max 500mA
PCB Size	38.0 x 38.0 x 24.7 mm
System Compatibility	Windows XP (SP2, SP3), Vista, 7, 8, 10, 11 Android, Mac OS, Linux or OS with UVC UAC Driver, Raspberry Pi by USB Port
Software for USB Camera	AMCAP, Webcam Viewer, V4L2 Controls Contacam, VLC Player, MotionEye OS iSpy, ZoneMider, Yawcam
Lens Type	650nm IR Cut
Operating Temperature	-20°C to +70°C

Wide Compatibility with Windows, Android, Mac OS, Linux, and Raspberry Pi

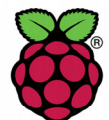

Windows® 안드로이드 Mac™ OS Linux Raspberry Pi

IMT-USB-M2-50200-A85 50MP Auto Focus USB 2.0 Camera Module

Format	Resolution	Frame Rate
		USB 2.0
MJPEG	1280 x 720 (720P)	30 FPS
	1920 x 1080 (1080P)	30 FPS
	3840 x 2160 (8MP)	20 FPS
	4080 x 3060 (12MP)	10 FPS
	8160 x 6120 (50MP)	5 FPS



IMT-USB-M2-50200-A85 50MP Auto Focus USB 2.0 Camera Module

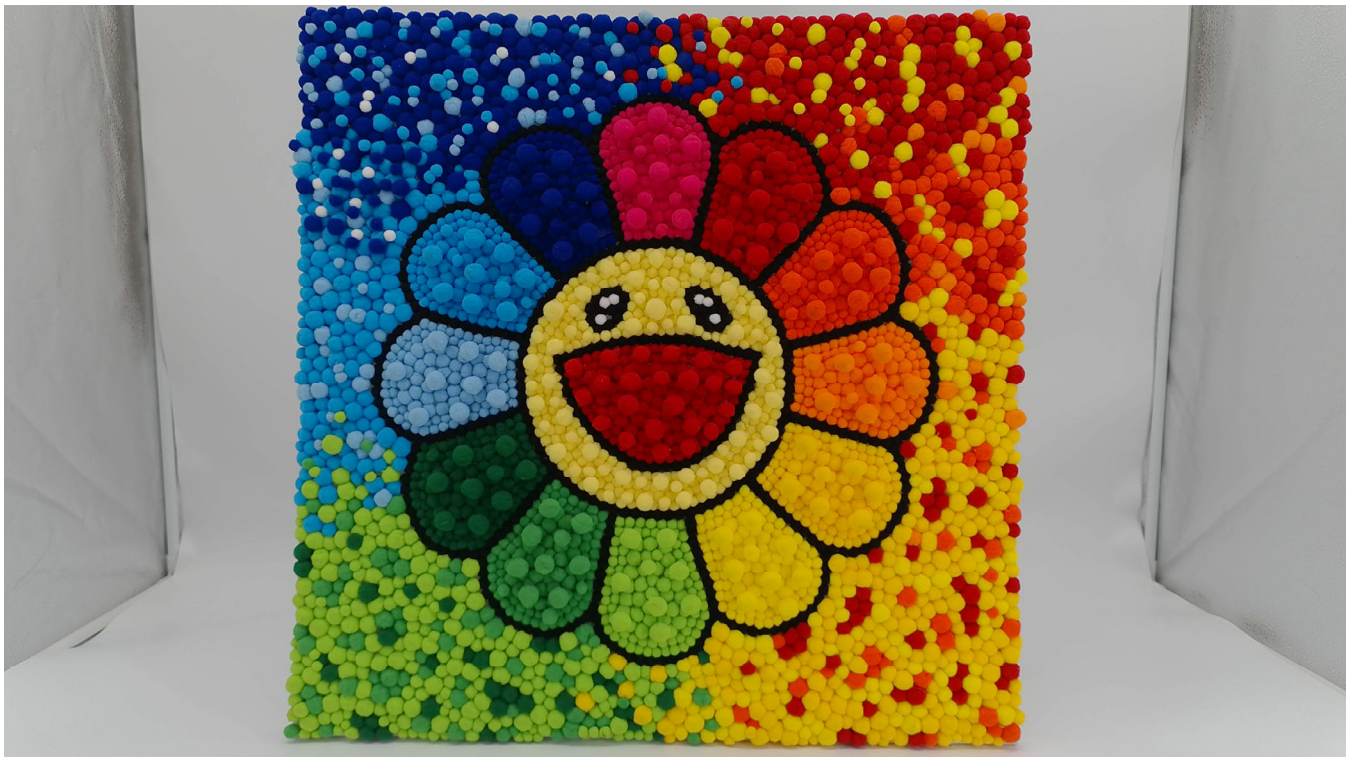
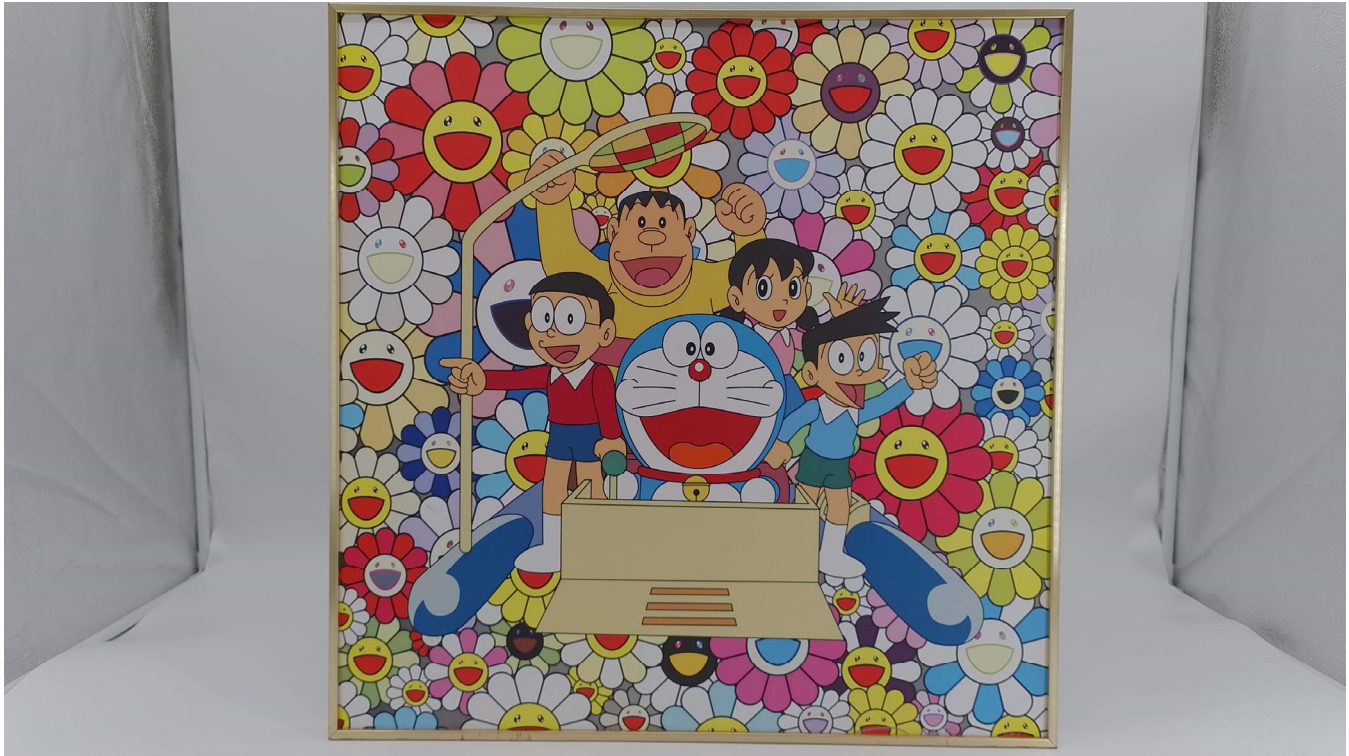

IMT-USB-M2-50200-A85 50MP Auto Focus USB 2.0 Camera Module

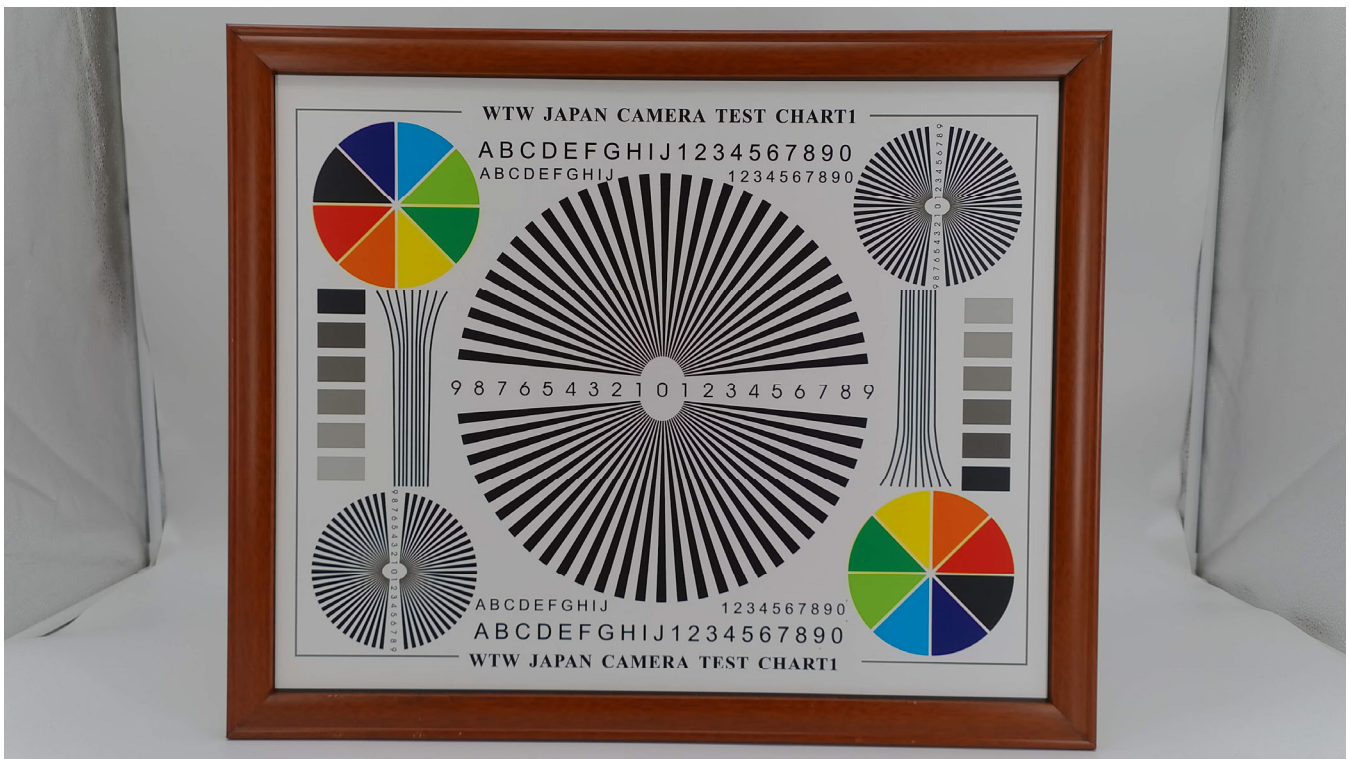

ROHS	
PIN	SIGNAL
1	USB_5V
2	DM(-)
3	DP(+)
4	GND
5	GND

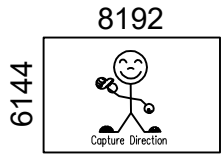

Version	Mark	Information	Date
V1.0	PD	First Version	2023-06-16

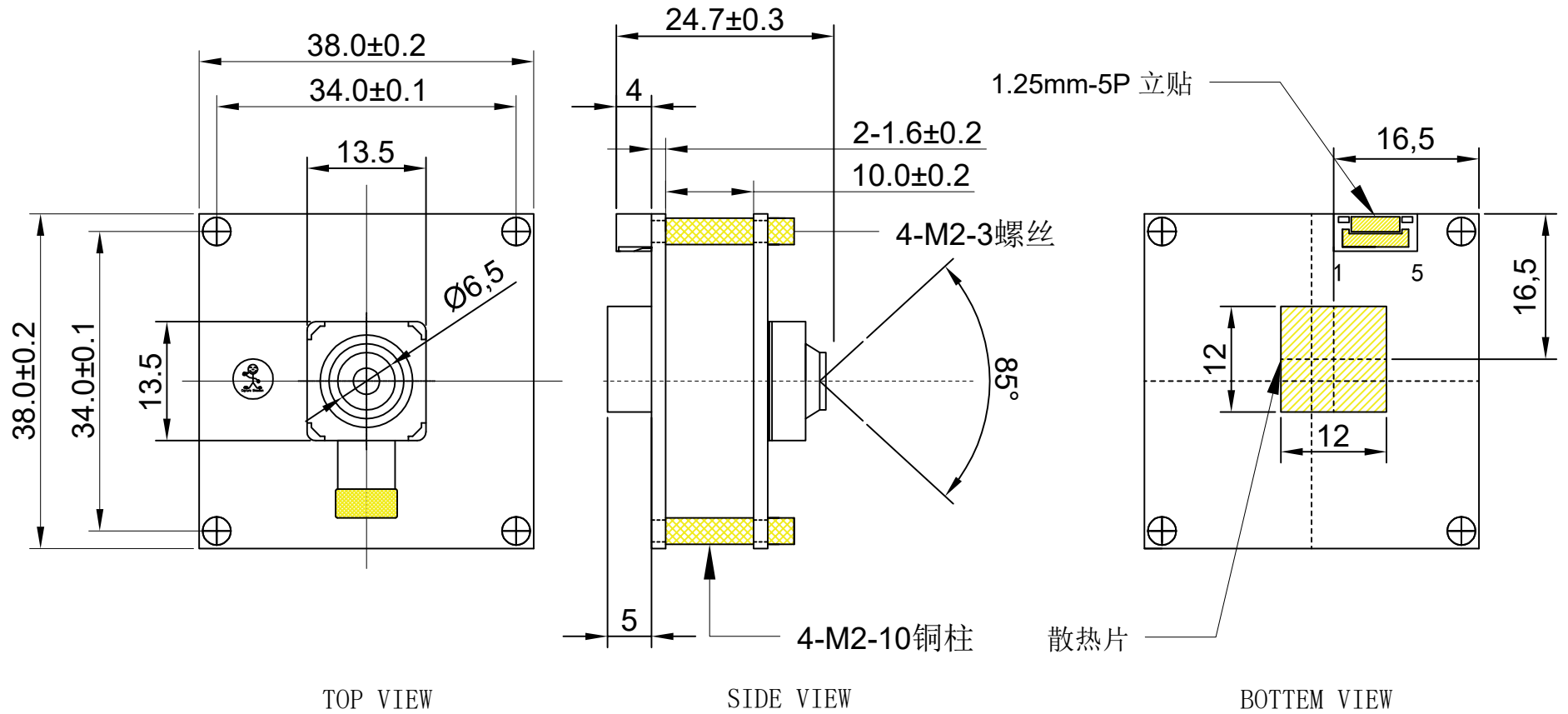

Parameters:
1、 Sensor specification:
 Image Sensor: 50M (PDAF)
 Pixel Size: 1.0umX1.0um
 Lens Type: 1/1.56

2、 Lens specification:
 FOV: D:85.5°
 F/NO.: 1.8
 TV distortion: ≤1.0%

www.InMakerTech.com

Designed By	Lu	Model Name:	M2-50200		
Checked By	He cheng	Projection Type:	Unit:	Material:	
			mm	-----	
		Scale:	Sheet:	Version:	
		1:1	1 of 1	1/0	



Cameras Applications



Automotive Driver Pilot



Live Streaming



Video Conference



Eye Tracker Biometric Detection



Machine Vision



Agricultural Monitor



Night Vision Security



Drone and Sports Eagle Eyes



Interactive Pet Camera



Camera Module Pinout Definition Reference Chart

OmniVision	Sony	Samsung	On-Semi	Aptina	Himax	GalaxyCore	PixArt	SmartSens	Sensors
Pin Signal		Description							
DGND GND		ground for digital circuit							
AGND		ground for analog circuit							
PCLK DCK		DVP PCLK output							
XCLR PWDN XSHUTDOWN STANDBY		power down active high with internal pull-down resistor							
MCLK XVCLK XCLK INCK		system input clock							
RESET RST		reset active low with internal pull-up resistor							
NC NULL		no connect							
SDA SIO_D SIOD		SCCB data							
SCL SIO_C SIOC		SCCB input clock							
VSYNC XVS FSYNC		DVP VSYNC output							
HREF XHS		DVP HREF output							
DOVDD		power for I/O circuit							
AFVDD		power for VCM circuit							
AVDD		power for analog circuit							
DVDD		power for digital circuit							
STROBE FSTROBE		strobe output							
FSIN		synchronize the VSYNC signal from the other sensor							
SID		SCCB last bit ID input							
ILPWM		mechanical shutter output indicator							
FREQ		frame exposure / mechanical shutter							
GPIO		general purpose inputs							
SLASEL		I2C slave address select							
AFEN		CEN chip enable active high on VCM driver IC							
MIPI Interface									
MDN0 DN0 MD0N DATA_N DMO1N		MIPI 1st data lane negative output							
MDP0 DP0 MD0P DATA_P DMO1P		MIPI 1st data lane positive output							
MDN1 DN1 MD1N DATA2_N DMO2N		MIPI 2nd data lane negative output							
MDP1 DP1 MD1P DATA2_P DMO2P		MIPI 2nd data lane positive output							
MDN2 DN2 MD2N DATA3_N DMO3N		MIPI 3rd data lane negative output							
MDP2 DP2 MD2P DATA3_P DMO3P		MIPI 3rd data lane positive output							
MDN3 DN3 MD3N DATA4_N DMO4N		MIPI 4th data lane negative output							
MDP3 DP3 MD3P DATA4_P DMO4P		MIPI 4th data lane positive output							
MCN CLKN CLK_N DCKN		MIPI clock negative output							
MCP CLKP MCP CLK_P DCKN		MIPI clock positive output							
DVP Parallel Interface									
D0 DO0 Y0		DVP data output port 0							
D1 DO1 Y1		DVP data output port 1							
D2 DO2 Y2		DVP data output port 2							
D3 DO3 Y3		DVP data output port 3							
D4 DO4 Y4		DVP data output port 4							
D5 DO5 Y5		DVP data output port 5							
D6 DO6 Y6		DVP data output port 6							
D7 DO7 Y7		DVP data output port 7							
D8 DO8 Y8		DVP data output port 8							
D9 DO9 Y9		DVP data output port 9							
D10 DO10 Y10		DVP data output port 10							
D11 DO11 Y11		DVP data output port 11							



Camera Reliability Test

Reliability Inspection Item		Testing Method	Acceptance Criteria	
Category	Item			
Environmental	Storage Temperature	High 60°C 96 Hours	Temperature Chamber	No Abnormal Situation
		Low -20°C 96 Hours	Temperature Chamber	No Abnormal Situation
	Operation Temperature	High 60°C 24 Hours	Temperature Chamber	No Abnormal Situation
		Low -20°C 24 Hours	Temperature Chamber	No Abnormal Situation
	Humidity	60°C 80% 24 Hours	Temperature Chamber	No Abnormal Situation
	Thermal Shock	High 60°C 0.5 Hours Low -20°C 0.5 Hours Cycling in 24 Hours	Temperature Chamber	No Abnormal Situation
Physical	Drop Test (Free Falling)	Without Package 60cm	10 Times on Wood Floor	Electrically Functional
		With Package 60cm	10 Times on Wood Floor	Electrically Functional
	Vibration Test	50Hz X-Axis 2mm 30min	Vibration Table	Electrically Functional
		50Hz Y-Axis 2mm 30min	Vibration Table	Electrically Functional
		50Hz Z-Axis 2mm 30min	Vibration Table	Electrically Functional
	Cable Tensile Strength Test	Loading Weight 4 kg 60 Seconds Cycling in 24 Hours	Tensile Testing Machine	Electrically Functional
Electrical	ESD Test	Contact Discharge 2 KV	ESD Testing Machine	Electrically Functional
		Air Discharge 4 KV	ESD Testing Machine	Electrically Functional
	Aging Test	On/Off 30 Seconds Cycling in 24 Hours	Power Switch	Electrically Functional
	USB Connector	On/Off 250 Times	Plug and Unplug	Electrically Functional





Camera Inspection Standard

Inspection Item		Inspection Method	Standard of Inspection		
Category	Item				
Appearance	FPC / PCB	Color	The Naked Eye	Major Difference is Not Allowed.	
		Be Torn/Chopped	The Naked Eye	Copper Crack Exposure is Not Allowed.	
		Marking	The Naked Eye	Clear, Recognizable (Within 30cm Distance)	
	Holder	Scratches	The Naked Eye	The Inside Crack Exposure is Not Allowed	
		Gap	The Naked Eye	Meet the Height Standard	
		Screw	The Naked Eye	Make Sure Screws Are Presented (If Any)	
		Damage	The Naked Eye	The Inside Crack Exposure is Not Allowed	
	Lens	Scratch	The Naked Eye	No Effect On Resolution Standard	
		Contamination	The Naked Eye	No Effect On Resolution Standard	
		Oil Film	The Naked Eye	No Effect On Resolution Standard	
		Cover Tape	The Naked Eye	No Issue On Appearance.	
	Function	Image	No Communication	Test Board	Not Allowed
			Bright Pixel	Black Board	Not Allowed In the Image Center
Dark Pixel			White board	Not Allowed In the Image Center	
Blurry			The Naked Eye	Not Allowed	
No Image			The Naked Eye	Not Allowed	
Vertical Line			The Naked Eye	Not Allowed	
Horizontal Line			The Naked Eye	Not Allowed	
Light Leakage			The Naked Eye	Not Allowed	
Blinking Image			The Naked Eye	Not Allowed	
Bruise			Inspection Jig	Not Allowed	
Resolution			Chart	Follows Outgoing Inspection Chart Standard	
Color			The Naked Eye	No Issue	
Noise			The Naked Eye	Not Allowed	
Corner Dark			The Naked Eye	Less Than 100px By 100px	
Color Resolution			The Naked Eye	No Issue	
Dimension	Height	The Naked Eye	Follows Approval Data Sheet		
	Width	The Naked Eye	Follows Approval Data Sheet		
	Length	The Naked Eye	Follows Approval Data Sheet		
	Overall	The Naked Eye	Follows Approval Data Sheet		

IMT Package Solutions

IMT Camera Module



Complete with Lens Protection Film



Tray with Grid and Space



Place Cameras on the Tray

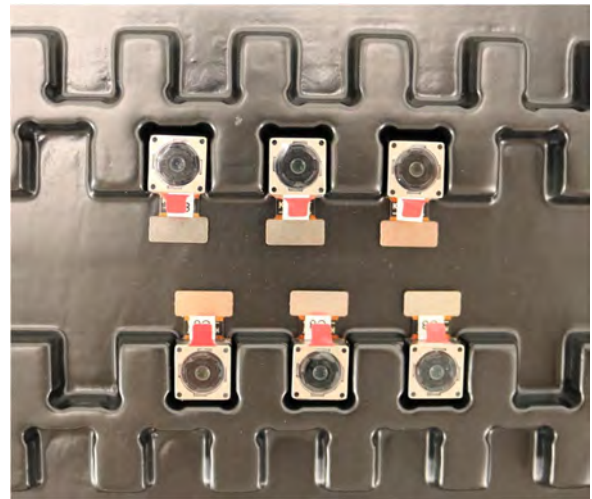

IMT Package Solutions

Full Tray of Cameras

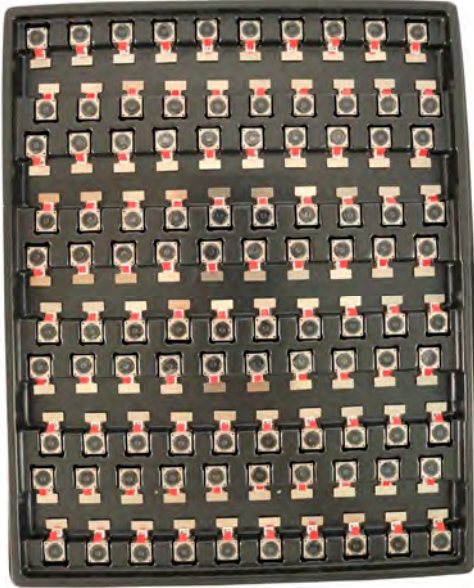

Cover Tray with Lid

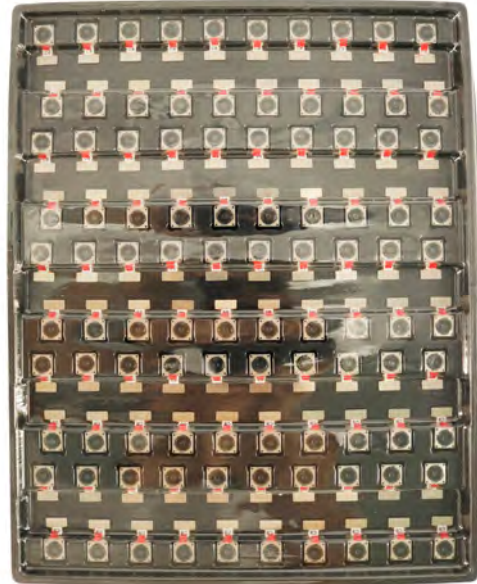

Place Tray into Anti-Static Bag



Vacuum the Anti-Static Bag





IMT Package Solutions

Sealed Vacuum Anti-Static Bag with Labels

1. Model and Description
2. Quantity
3. Manufacturing Date Code
4. Caution





IMT Package Solutions

Place Foam Sheets Between Tray Bags



Foam Sheets are Larger Than Trays



Place Foam Sheets and Trays into Box



Foam Sheets are Tightly Fitting in Box



Seal the Carbon Box



Label the Carbon Shipping Box





IMT Package Solutions

USB Camera Module

Complete with Lens Protection Film

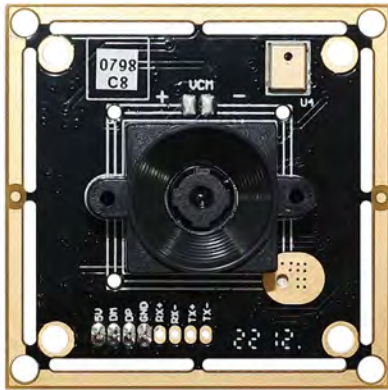

Place Camera Sample into Anti-Static Bag

Place USB Cameras into Tray



Seal the Tray with Anti-Static Bag

Label the Carbon Shipping Box



IMT Package Solutions

Place Camera Sample into Anti-Static Bag



Place Connectors into Anti-Static Bag



Label the Sample Bags



Place Connectors into Reel



Place Samples into the Carbon Box



Place Connectors into the Carbon Box



Company INNOMAKER

InnoMaker Technologies Limited (IMT) was established in 2017, a next-generation technology driven manufacturer specialized in research, design, and produce of audio and video products. IMT is occupying 20,000 square feet automated plants with 100 employees of annual throughput 30,000,000 units cameras.

IMT provides OEM, ODM design, contract manufacturing, and builds the camera products. You may provide the requirements to us, even with a hand draft, our sales and engineering work together to meet your needs. We consider ourselves your last-term partner in developing practical and innovative solutions.

Our team covers everything from initial concept development to mass produced product. IMT specializes in customized camera design, raw material, electronic engineering, firmware/software development, product testing, and packing design. Our experienced strategic supply systems offer a robust and dependable manufacturing capacity for orders of various sizes.



Limited Warranty

IMT provides the following limited warranty if you purchased the Product(s) directly from IMT company or from IMT's website www.InMakerTech.com. Product(s) purchased from other sellers or sources are not covered by this Limited Warranty. IMT guarantees that the Product(s) will be free from defects in materials and workmanship under normal use for a period of one (1) year from the date you receive the product ("Warranty Period").

For all Product(s) that contain or develop material defects in materials or workmanship during the Warranty Period, IMT will, at its sole option, either: (i) repair the Product(s); (ii) replace the Product(s) with a new or refurbished Product(s) (replacement Product(s) being of identical model or functional equivalent); or (iii) provide you a refund of the price you paid for the Product(s).

This Limited Warranty of IMT is solely limited to repair and/or replacement on the terms set forth above. IMT is not reliable or responsible for any subsequent events.





InnoMaker Technologies



Your Trusted Optical Partner

Our Company Strength

Powerful Factory



Professional Service



Promised Delivery

